

Features

- Precision Monitor of(2.5V/3.0V/3.3V/5.0V) power supply voltage
- Full specified over temperature
- Manual reset input
- Available in four output configuration
- Push-pull RESET Active low(APX811)
- Push-pull RESET Active high(APX812)
- Power-on reset generator with fixed delay time 200ms
- SOT143: Available in "Green" Molding Compound (No Br, Sb)
- Lead Free Finish/RoHS Compliant (Note 1)

General Description

The APX811/812 are used for microprocessor supervisory circuit to monitor the power supplies in These circuit perform a single function: they assert a reset signal whenever the Vcc supply voltage declines below a preset threshold, keeping it asserted for at least 240ms after Vcc has risen above the reset threshold. Reset thresholds suitable for operation with a variety of supply voltages are available. The APX811/812 have push-pull outputs. The APX811 has an active low $\overline{\text{RESET}}$ output, while the APX812 has an active high RESET output.

The APX811/812 devices incorporate a manual reset input, $\overline{\text{MR}}$. A low level at $\overline{\text{MR}}$ causes RESET to become active.

The APX811/2 are targeted at 2.5V, 3V, 3.3V and 5V powered systems and are available with different threshold voltages to meet the exact needs of the system. They are available in the space saving SOT143 package and operate over the whole industrial temperature range, -40 to 85°C.

Applications

- Computers
- Controllers
- Intelligent Instruments
- Critical uP and UC power Monitoring
- Portable/Battery powered Equipment
- Automotive

Typical Application Circuit



Ordering Information

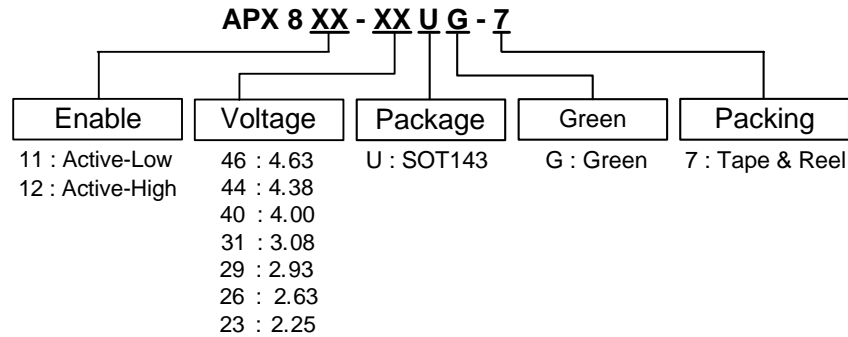

Device	Package Code	Packaging (Note 2)	7" Tape and Reel	
			Quantity	Part Number Suffix
APX811-XXUG-7	U	SOT143	3000/Tape & Reel	-7
APX812-XXUG-7	U	SOT143	3000/Tape & Reel	-7

- Notes:
1. EU Directive 2002/95/EC (RoHS). All applicable RoHS exemptions applied. Please visit our website at http://www.diodes.com/products/lead_free.html.
 2. Pad layout as shown on Diodes Inc. suggested pad layout document AP02001, which can be found on our website at <http://www.diodes.com/datasheets/ap02001.pdf>.

Pin Assignments

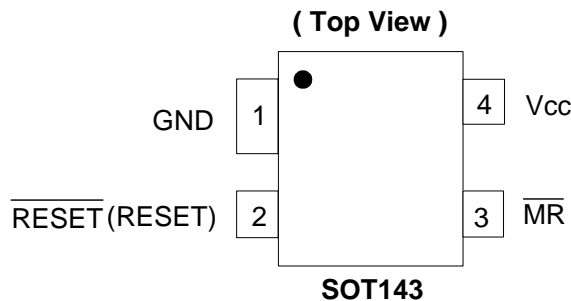

Pin Descriptions

Pin Name	Description
GND	Ground
$\overline{\text{RESET}}$ (RESET)	Reset output Pin L: for APX811 H: for APX812
VCC	Operating Voltage Input
$\overline{\text{MR}}$	Manual reset (Active Low)

Block Diagram



Absolute Maximum Ratings

Symbol	Parameter	Rating	Unit
ESD HBM	Human Body Model ESD protection	3	kV
ESD MM	Machine Model ESD Protection	500	V
V_{CC}	Supply voltage	-0.3~7	V
V_{RESET}	RESET	-0.3 to ($V_{CC}+0.3$)	V
I_{CC}	Input Current, Vcc	20	mA
I_O	Output current	20	mA
P_D	Power dissipation	320	mW

Recommended Operating Conditions

Symbol	Parameter	Min	Max	Unit
V_{CC}	Supply Voltage	1.1	5.5	V
V_{IN}	Input Voltage	0	($V_{CC}+0.3$)	V
T_A	Operating Ambient Temperature	-40	85	°C

Electrical Characteristics (T_A = 25°C)

T_A = -40 to 85 °C unless otherwise note. Typical values are at T_A = +25 °C.

Symbol	Parameter	Test Conditions	Min	Typ.	Max	Unit
V _{CC}	V _{CC} Range		1.0		5.5	V
I _{CC}	Supply Current	V _{th} + 0.2V		30	40	μA
V _{th}	Reset threshold	T _A = 25 °C.	2.22	2.25	2.28	V
			2.59	2.63	2.67	V
			2.89	2.93	2.98	V
			3.03	3.08	3.13	V
			3.94	4.00	4.06	V
			4.31	4.38	4.45	V
			4.56	4.63	4.70	V
t _s	Set-up Time	V _{CC} = V _{th} to (V _{th} - 100mV)		20		μs
V _{OL}	RESET Output Voltage Low (APX811)	V _{CC} = V _{th} - 0.2, I _{SINK} = 1.2mA			0.3	V
		V _{CC} = V _{th} - 0.2, I _{SINK} = 3.2mA			0.4	
		V _{CC} > 1.0V, I _{SINK} = 50uA			0.3	
V _{OH}	RESET Output Voltage-High (APX811)	V _{CC} > V _{th} + 0.2, I _{SOURCE} = 500uA	0.8V _{CC}			V
		V _{CC} > V _{th} + 0.2, I _{SOURCE} = 800uA	V _{CC} - 1.5			
V _{OL}	RESET Output Voltage-Low (APX812)	V _{CC} = V _{th} + 0.2, I _{SINK} = 1.2mA			0.3	V
		V _{CC} = V _{th} + 0.2, I _{SINK} = 3.2mA			0.4	
V _{OH}	RESET Output Voltage-High (APX812)	1.8V < V _{CC} < V _{th} - 0.2, I _{SOURCE} = 150uA	0.8 V _{CC}			V
θ _{JA}	Thermal Resistance Junction-to-Ambient	SOT143 (Note 3)		240		°C/W
θ _{JC}	Thermal Resistance Junction-to-Case	SOT143 (Note 3)		71		°C/W

Notes: 3. Test condition for SOT143: Device mounted on FR-4 substrate, 1" x 1", 2oz, copper, single-sided, PC boards.

Timing requirements (T_A = 25°C)

Symbol	Parameter	Test Conditions	Min	Typ.	Max	Unit
t _w	Pulse Width at MR	V _{CC} > V _{th} + 0.2V, V _{IL} = 0.3 × V _{CC} , V _{IH} = 0.7 × V _{CC}	100	-	-	ns

Switching Characteristics (T_A=25°C)

Symbol	Parameter	Test Conditions	Min	Typ.	Max	Unit
t _d	Delay Time	APX811/812 V _{CC} > V _{th} +0.2V, See timing diagram	140	200	280	ms
t _{PHL}	Propagation (Delay) Time, High-to-low-level Output	$\overline{\text{MR}}$ to $\overline{\text{RESET}}$ delay (APX811/812)	-	-	0.1	μs
		V _{CC} to $\overline{\text{RESET}}$ delay	-	-	25	μs
t _{PLH}	Propagation (Delay) Time, Low-to-high-level Output	$\overline{\text{MR}}$ to RESET delay (APX811/812)	-	-	0.1	μs
		V _{CC} to RESET delay (APX811/812)	-	-	25	μs

Timing Diagram

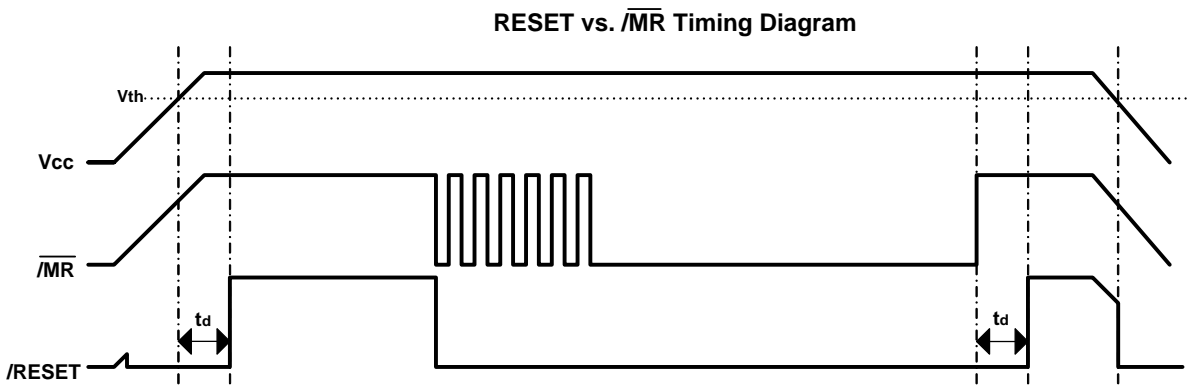
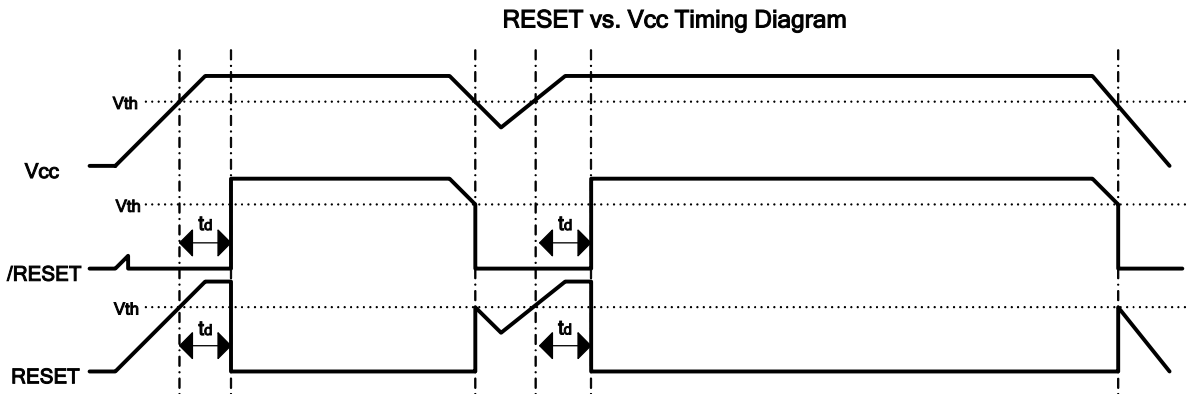

Typical Performance Characteristics

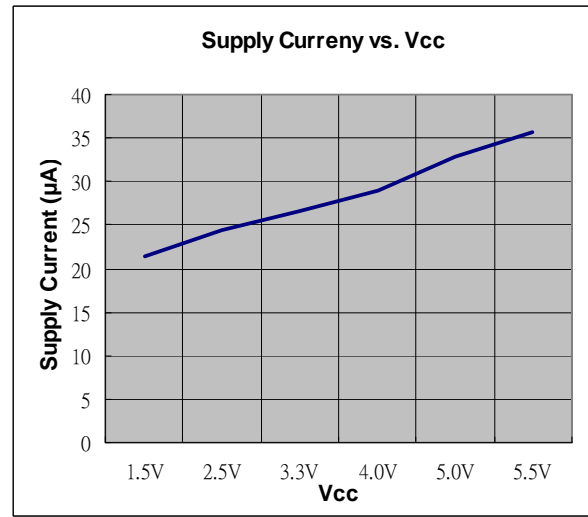
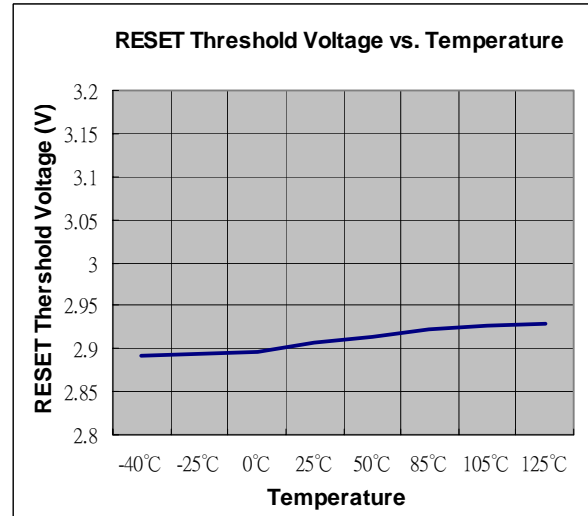

Application Information

A microprocessor's (μ P's) reset input starts the μ P in a known state. The APX811/812 asserts reset to prevent code-execution errors during power-up, power-down, or brownout conditions. They assert a reset signal whenever the V_{CC} supply voltage declines below a preset threshold or the \overline{MR} pin is brought low, keeping it asserted for at least 240ms after V_{CC} has risen above the reset threshold. The APX811/812 have a push-pull output stage.

The APX811/812 reset output is guaranteed to be logic low for the APX811 and high the APX812 for $V_{CC} > 1V$. Once V_{CC} exceeds the reset threshold, an internal timer keeps \overline{RESET} output low (and RESET high for the APX812) for the reset timeout period. After this interval, the APX811's \overline{RESET} output goes high (APX812's RESET output goes low). If a brownout condition occurs (V_{CC} dips below the reset threshold), the APX811's \overline{RESET} output goes low (APX812's RESET output goes high). Any time V_{CC} goes below the reset threshold, the internal timer resets to zero, and \overline{RESET} goes low (RESET goes high). The internal timer starts after V_{CC} returns above the reset threshold, and \overline{RESET} remains low (RESET remains high) for the reset timeout period.

Ensuring a Valid Reset Output Down to $V_{CC} = 0$

When V_{CC} falls below 1V, the APX811 \overline{RESET} no longer sinks current—it becomes an open circuit. Therefore, high-impedance CMOS logic inputs connected to \overline{RESET} can drift to undetermined voltages. This presents no problem in most applications since most μ P and other circuitry is inoperative with V_{CC} below 1V. However, in applications where \overline{RESET} must be valid down to 0V, adding a pull down resistor to \overline{RESET} causes any stray leakage currents to flow to ground, holding \overline{RESET} low. R1's value is not critical; 100k is large enough not to load \overline{RESET} and small enough to pull \overline{RESET} to ground.

For the APX812 if RESET is required to remain valid for $V_{CC} < 1V$ then a 100k Ω pull-up resistor between RESET and V_{CC} is recommended.

Benefits of Highly Accurate Reset Threshold

Most μ P supervisor ICs has reset threshold voltages between 5% and 10% below the value of nominal supply voltages. This ensures a reset will not occur within 5% of the nominal supply, but will occur when the supply is 10% below nominal. When using ICs rated at only the nominal supply $\pm 5\%$, this leaves a zone of uncertainty where the supply is between 5% and 10% low, and where the reset may or may not be asserted.

Marking Information

(1) SOT143

(Top View)



XX : Identification code

Y : Year 0~9

W : Week : A~Z : 1~26 week;
a~z : 27~52 week; z represents
52 and 53 week

X : A~Z : Green

Device	Package	Identification Code
APX811-46U	SOT143	C2
APX811-44U	SOT143	C3
APX811-40U	SOT143	C4
APX811-31U	SOT143	C5
APX811-29U	SOT143	C6
APX811-26U	SOT143	C7
APX811-23U	SOT143	C8
APX812-46U	SOT143	C9
APX812-44U	SOT143	CA
APX812-40U	SOT143	CB
APX812-31U	SOT143	CC
APX812-29U	SOT143	CD
APX812-26U	SOT143	CE
APX812-23U	SOT143	CF

Package Information (All Dimensions in mm)

(1) Package Type: SOT143

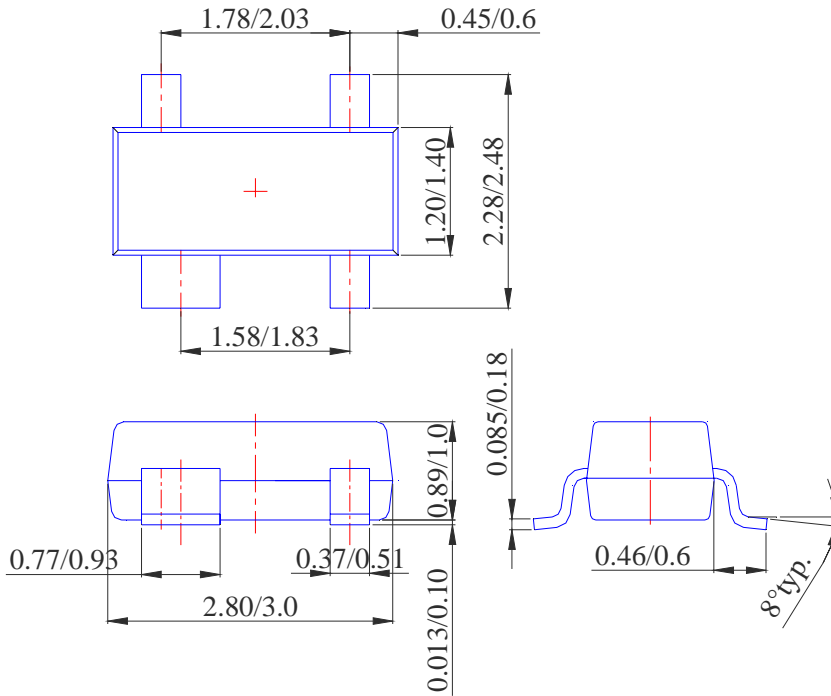

IMPORTANT NOTICE

DIODES INCORPORATED MAKES NO WARRANTY OF ANY KIND, EXPRESS OR IMPLIED, WITH REGARDS TO THIS DOCUMENT, INCLUDING, BUT NOT LIMITED TO, THE IMPLIED WARRANTIES OF MERCHANTABILITY AND FITNESS FOR A PARTICULAR PURPOSE (AND THEIR EQUIVALENTS UNDER THE LAWS OF ANY JURISDICTION).

Diodes Incorporated and its subsidiaries reserve the right to make modifications, enhancements, improvements, corrections or other changes without further notice to this document and any product described herein. Diodes Incorporated does not assume any liability arising out of the application or use of this document or any product described herein; neither does Diodes Incorporated convey any license under its patent or trademark rights, nor the rights of others. Any Customer or user of this document or products described herein in such applications shall assume all risks of such use and will agree to hold Diodes Incorporated and all the companies whose products are represented on Diodes Incorporated website, harmless against all damages.

Diodes Incorporated does not warrant or accept any liability whatsoever in respect of any products purchased through unauthorized sales channel.

Should Customers purchase or use Diodes Incorporated products for any unintended or unauthorized application, Customers shall indemnify and hold Diodes Incorporated and its representatives harmless against all claims, damages, expenses, and attorney fees arising out of, directly or indirectly, any claim of personal injury or death associated with such unintended or unauthorized application.

Products described herein may be covered by one or more United States, international or foreign patents pending. Product names and markings noted herein may also be covered by one or more United States, international or foreign trademarks.

LIFE SUPPORT

Diodes Incorporated products are specifically not authorized for use as critical components in life support devices or systems without the express written approval of the Chief Executive Officer of Diodes Incorporated. As used herein:

- A. Life support devices or systems are devices or systems which:
1. are intended to implant into the body, or
 2. support or sustain life and whose failure to perform when properly used in accordance with instructions for use provided in the labeling can be reasonably expected to result in significant injury to the user.
- B. A critical component is any component in a life support device or system whose failure to perform can be reasonably expected to cause the failure of the life support device or to affect its safety or effectiveness.

Customers represent that they have all necessary expertise in the safety and regulatory ramifications of their life support devices or systems, and acknowledge and agree that they are solely responsible for all legal, regulatory and safety-related requirements concerning their products and any use of Diodes Incorporated products in such safety-critical, life support devices or systems, notwithstanding any devices- or systems-related information or support that may be provided by Diodes Incorporated. Further, Customers must fully indemnify Diodes Incorporated and its representatives against any damages arising out of the use of Diodes Incorporated products in such safety-critical, life support devices or systems.

Copyright © 2009, Diodes Incorporated

www.diodes.com